

FLT-2

LED Flexible Module

- High beam effect efficiency
- Up to 8 m maximum length
- Low temperature

FLT-2 - 998 - N - K

1 2 3 4

- 1 Fixture name : FLT-2= LED Flexible Module FLare Line Clear
 2 Length : 500, 998, 1496, 1994 (other size possible)
 3 LED color : L22 = Light bulb (2200K)
 L25 = Light bulb (2500K)
 L27 = Light bulb (2700K)
 L30 = Light bulb (3000K)
 WW = Warm white (3500K)
 W = White (4000K)
 N = Neutral white (5000K)
 D = Daylight (6500K)
 None = standard/K = one end connector

- 4 Connector: indoor cove / display lighting
 Environment of use : 8m (7970mm)
 Maximum length in series :
 Driver : DC 24V

Color temperature CCT

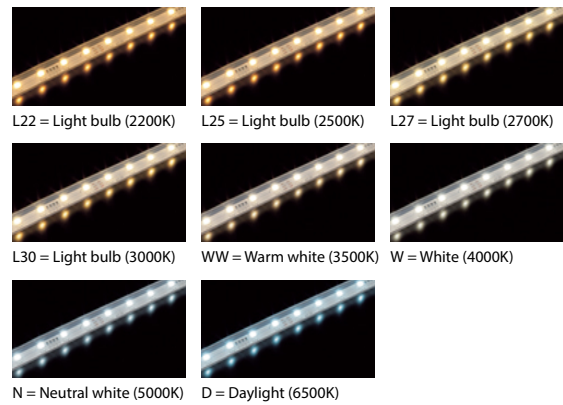

Photometric data

Measured fixture: FLT-2-998-N

Light Intensity distribution

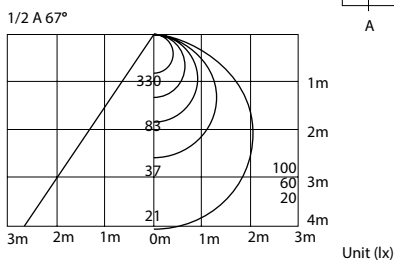

Candlepower Distribution

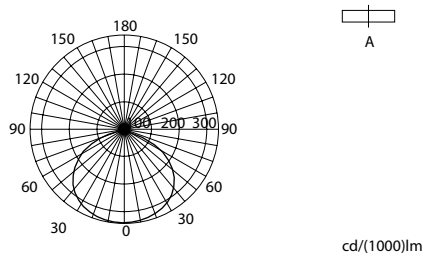

Dimensions

External dimension

Unit (mm)

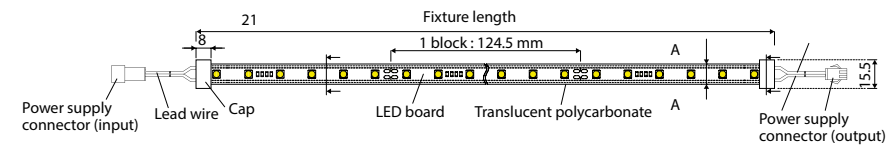

Cross sectional view A-A

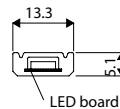

Cross sectional view B-B

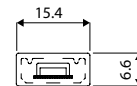

Connector dimension

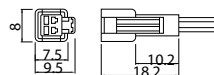

Power supply in:

Power supply out:

Cutting position

1 block : 124.5 mm (minimum length)

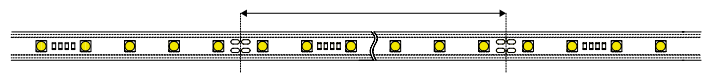

Can be cut every 124.5mm (1 unit = 6 LED)

- Cut the board at the position indicated by [CUT].
- Please take to not apply strength on the LED while cutting the board.
- After cutting secure the board with plastic cap option part.

Cutting position

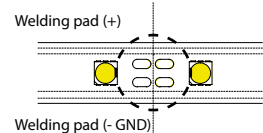

DC 24V standard specifications

Reference	Length (mm)	Weight (kg)	Number of LED	CRI (Ra)	Watts (W)	Amps (A)	Maximum length (m)	Luminous flux (lm)
FLT-2-500	500	0.04	24	> 80 Ra	4.4	0.19	8	490
FLT-2-998	998	0.07	48		8.9	0.37		980
FLT-2-1496	1496	0.11	72		13.1	0.55		1470
FLT-2-1994	1994	0.14	96		17.3	0.72		1960

Order made sizes

Reference	Length (mm)	Weight (kg)	No. of LED	Watts (W)	Amps (A)	Luminous flux (lm)
FLT-2-127	126.5	0.009	6	1.1	0.046	123
FLT-2-251	251	0.018	12	2.2	0.093	245
FLT-2-376	375.5	0.026	18	3.3	0.139	368
FLT-2-500	500	0.035	24	4.4	0.185	490
FLT-2-625	624.5	0.044	30	5.6	0.231	613
FLT-2-749	749	0.053	36	6.7	0.278	735
FLT-2-874	873.5	0.062	42	7.8	0.324	858
FLT-2-998	998	0.070	48	8.9	0.370	980
FLT-2-1123	1122.5	0.079	54	9.9	0.414	1103
FLT-2-1247	1247	0.088	60	11.0	0.458	1225
FLT-2-1372	1371.5	0.097	66	12.0	0.501	1348
FLT-2-1496	1496	0.106	72	13.1	0.545	1470
FLT-2-1621	1620.5	0.114	78	14.1	0.589	1589
FLT-2-1745	1745	0.123	84	15.2	0.633	1709
FLT-2-1870	1869.5	0.132	90	16.2	0.676	1828
FLT-2-1994	1994	0.141	96	17.3	0.720	1908
FLT-2-2119	2118.5	0.150	102	18.3	0.763	2023
FLT-2-2243	2243	0.158	108	19.4	0.807	2137
FLT-2-2368	2367.5	0.167	114	20.4	0.850	2252
FLT-2-2492	2492	0.176	120	21.4	0.894	2367
FLT-2-2617	2615.5	0.185	126	23.5	0.937	2481
FLT-2-2741	2741	0.194	132	24.6	0.980	2596
FLT-2-2866	2865.5	0.202	138	25.6	1.024	2710
FLT-2-2990	2990	0.211	144	25.6	1.067	2825
FLT-2-3115	3114.5	0.220	150	26.6	1.108	2935
FLT-2-3239	3239	0.229	156	27.6	1.150	3045
FLT-2-3364	3363.5	0.238	162	28.6	1.191	3155
FLT-2-3488	3488	0.246	168	29.6	1.232	3266
FLT-2-3613	3612.5	0.255	174	30.6	1.315	3376
FLT-2-3737	3737	0.264	180	31.5	1.356	3486
FLT-2-3862	3861.5	0.273	186	32.5	1.397	3596
FLT-2-3986	3986	0.282	192	33.5	1.397	3706

Reference	Length (mm)	Weight (kg)	No. of LED	Watts (W)	Amps (A)	Luminous flux (lm)
FLT-2-4111	4110.5	0.290	198	34.5	1.437	3814
FLT-2-4235	4235	0.299	204	35.4	1.476	3921
FLT-2-4360	4359.5	0.308	210	36.4	1.516	4029
FLT-2-4484	4484	0.317	216	37.3	1.555	4136
FLT-2-4609	4608.5	0.326	222	38.3	1.595	4244
FLT-2-4733	4733	0.334	228	39.2	1.634	4351
FLT-2-4858	4857.5	0.343	234	40.2	1.674	4459
FLT-2-4982	4982	0.352	240	41.1	1.714	4566
FLT-2-5107	5106.5	0.361	246	42.0	1.752	4673
FLT-2-5231	5231	0.370	252	43.0	1.790	4780
FLT-2-5356	5255.5	0.378	258	43.9	1.828	4887
FLT-2-5480	5480	0.387	264	44.8	1.866	4994
FLT-2-5605	5604.5	0.396	270	45.7	1.904	5100
FLT-2-5729	5729	0.405	276	46.6	1.942	5207
FLT-2-5854	5883.4	0.414	282	47.5	1.980	5314
FLT-2-5978	5978	0.422	288	48.4	2.018	5421
FLT-2-6103	6102.5	0.431	294	49.3	2.054	5525
FLT-2-6227	6227	0.440	300	50.2	2.090	5628
FLT-2-6352	6351.5	0.449	306	51.0	2.126	5732
FLT-2-6476	6476	0.458	312	51.9	2.163	5836
FLT-2-6601	6600.5	0.466	318	52.8	2.199	5939
FLT-2-6725	6725	0.475	324	53.6	2.235	6043
FLT-2-6850	6849.5	0.484	330	54.5	2.271	6146
FLT-2-6974	6974	0.493	336	55.4	2.308	6250
FLT-2-7099	7098.5	0.502	342	56.3	2.344	6349
FLT-2-7223	7223	0.510	348	57.1	2.380	6448
FLT-2-7348	7347.5	0.519	354	58.0	2.416	6547
FLT-2-7472	7472	0.528	360	58.9	2.453	6646
FLT-2-7597	7596.5	0.537	366	59.7	2.489	6745
FLT-2-7721	7721	0.546	372	60.6	2.525	6844
FLT-2-7846	7845.5	0.554	378	61.5	2.561	6943
FLT-2-7970	7970	0.563	384	62.3	2.598	7042

* Maximum length 8m. If you want to connect more than 8m, please connect the system in parallel.

* Standard sizes. For other dimensions, please contact us.

Option parts

Mounting bracket FLT-CR

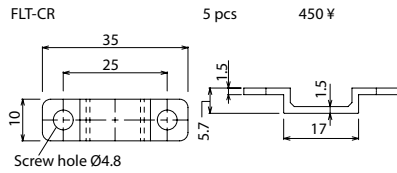

Mounting clip FLT-RLC

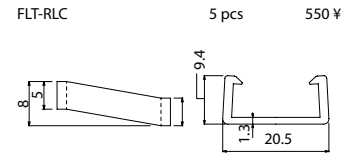

Mounting rail FLT-RL

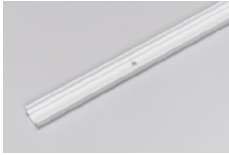

FLT-RL-500	470mm	1 pcs	1500 ¥
FLT-RL-1000	970mm	1 pcs	1700 ¥
FLT-RL-1500	1470mm	1 pcs	2000 ¥
FLT-RL-2900	1970mm	1 pcs	2500 ¥

In case of FLT-RL-500/1000 you shall use 5 mounting clip.
In case of FLT-RL-1500/2000 you shall use 10 mounting clip.

Cap FLT-C

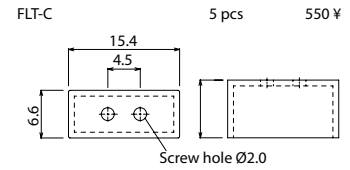
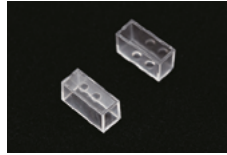

Jumper cable SMX



SMX-80	80 mm	1 pcs	500 ¥
SMX-200	200 mm	1 pcs	500 ¥
SMX-300	300 mm	1 pcs	500 ¥
SMX-400	400 mm	1 pcs	600 ¥

SMX-500	500 mm	1 pcs	600 ¥
SMX-1000	1000 mm	1 pcs	600 ¥
SMX-2000	2000 mm	1 pcs	1200 ¥
SMX-3000	3000 mm	1 pcs	1800 ¥
SMX-4000	4000 mm	1 pcs	2400 ¥

Power supply out cable DGC



DGC-1	500mm	1 connector	700 ¥
DGC-2	500mm	2 connectors	900 ¥
DGC-3	500mm	3 connectors	1100 ¥
DGC-4	500mm	4 connectors	1300 ¥

Power supply in lead cable DGN



DGN-2500	2500mm	1 pcs	1350 ¥
----------	--------	-------	--------

Power supply unit (OSRAM OT)



OT30/100-200-24-T	30W	1 pcs	Open price
OT60/100-200-24-T	60W	1 pcs	Open price
OT90/100-200-24-T	90W	1 pcs	Open price
OT150/100-200-24-T	150W	1 pcs	Open price

Input AC90~240V, output DC24V.
Comply with CE, UL, PSE standards. IP 66 water proof rating.

DC 24V dimmer FMC-24S/R



FMC-24S/R	1 pcs	34500 ¥
-----------	-------	---------

Available in 3 colors:

- White
- Grey
- Black

DC 24V simple dimmer FSD-24

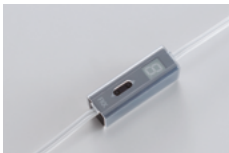

FSD-24	1 pcs	9900 ¥
--------	-------	--------

Installation / Power supply connection

Mounting rail installation

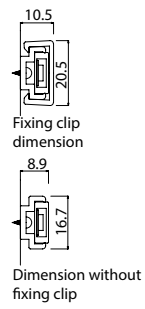
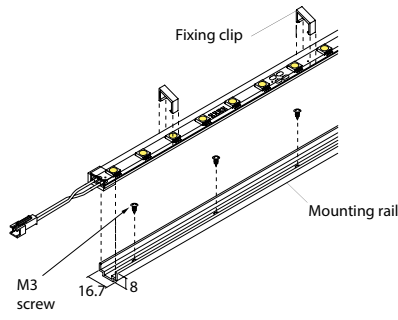

Mounting bracket installation

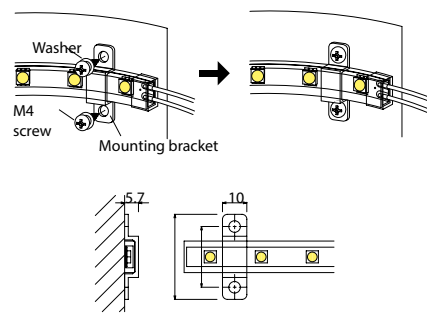

* Please always use washers when fixing the brackets.

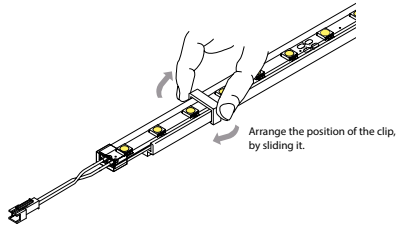

Cutting the fixture

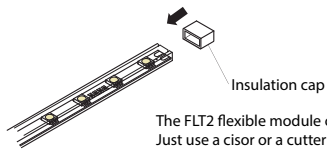

The FLT2 flexible module can be cut at every section of 124.5 mm. Just use a pair of scissors or a cutter to cut on indicated mark on the fixture.

Installation / Power supply connection

