

FLT-3PG

LED Flexible Module



- Built-in **phosphorescence** function, produce bright light even when the power is off
- Visible in the dark even after 10 hours
- Up to 6.5 m standard length



FLT-3PG - 1004 - N - K

1 Fixture name : FLT-3PG= LED Flexible Module FLare Line PLC
 Length : 58mm~6482mm
 3 LED color : L25 = Light bulb (2500K)
 L27 = Light bulb (2700K)
 L30 = Light bulb (3000K)
 WW = Warm white (3500K)
 W = White (4000K)
 N = Neutral white (5000K)
 D = Daylight (6500K)
 None = standard/K = one end connector

4 Connector: None = standard/K = one end connector

Environment of use : indoor cove / display lighting
 Maximum length in series : 6.5m (6482mm) (longer possible upon request)
 Driver : DC 24V
 CRI: > 80 Ra

Color temperature CCT

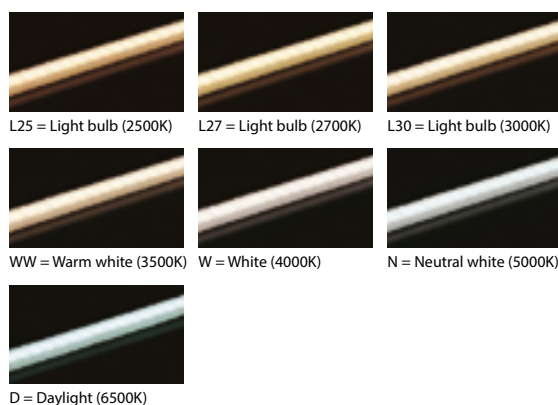

Photometric data

Measured fixture: FLT-3PG-1004-N

Light Intensity distribution

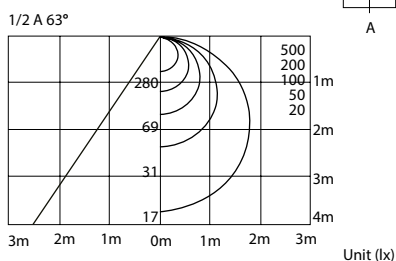

Candlepower Distribution

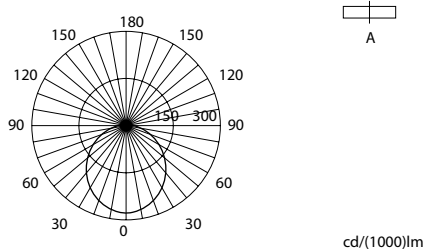

Dimensions

Unit (mm)

External dimension

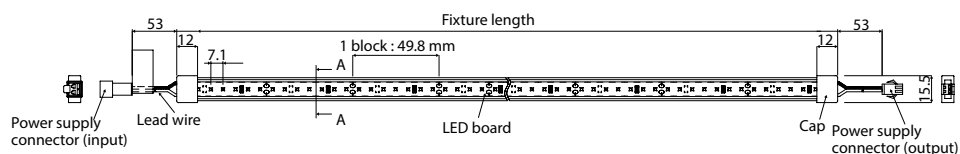

Cross sectional view A-A

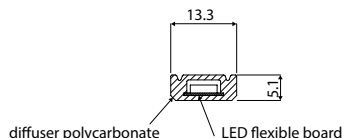

Connector dimension

Power supply in:

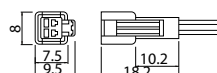

Power supply out:

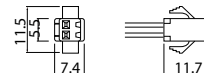

Order made sizes

Reference	Length (mm)	Weight (kg)	No. of LED	Watts (W)	Amps (A)	Luminous flux (lm)
FLT-3PG-58	58	0.009	7	0.5	0.02	45
FLT-3PG-108	108	0.013	14	1.0	0.04	90
FLT-3PG-157	157	0.017	21	1.4	0.06	135
FLT-3PG-207	207	0.021	28	1.9	0.08	180
FLT-3PG-257	257	0.025	35	2.4	0.10	225
FLT-3PG-307	307	0.029	42	2.9	0.12	270
FLT-3PG-357	357	0.033	49	3.4	0.14	315
FLT-3PG-406	406	0.037	56	3.8	0.16	360
FLT-3PG-456	456	0.041	63	4.3	0.18	405
FLT-3PG-506	506	0.045	70	4.8	0.20	450
FLT-3PG-556	556	0.049	77	5.3	0.22	495
FLT-3PG-606	606	0.053	84	5.8	0.24	540
FLT-3PG-655	655	0.057	91	6.2	0.26	585
FLT-3PG-705	705	0.061	98	6.7	0.28	630
FLT-3PG-755	755	0.065	105	7.2	0.30	675
FLT-3PG-805	805	0.069	112	7.7	0.32	720
FLT-3PG-855	855	0.073	119	8.2	0.34	765
FLT-3PG-904	904	0.077	126	8.6	0.36	810
FLT-3PG-954	954	0.081	133	9.1	0.38	855
FLT-3PG-1004	1004	0.085	140	9.6	0.40	900
FLT-3PG-1054	1054	0.089	147	10.1	0.42	945
FLT-3PG-1104	1104	0.093	154	10.6	0.44	990
FLT-3PG-1153	1153	0.097	161	11.0	0.46	1035
FLT-3PG-1203	1203	0.101	168	11.5	0.48	1080
FLT-3PG-1253	1253	0.105	175	12.0	0.50	1125
FLT-3PG-1303	1303	0.109	182	12.5	0.52	1170
FLT-3PG-1353	1353	0.113	189	13.0	0.54	1215
FLT-3PG-1402	1402	0.117	196	13.4	0.56	1260
FLT-3PG-1452	1452	0.121	203	13.9	0.58	1305
FLT-3PG-1502	1502	0.125	210	14.4	0.60	1350
FLT-3PG-1552	1552	0.129	217	14.9	0.62	1395
FLT-3PG-1602	1602	0.133	224	15.4	0.64	1440
FLT-3PG-1651	1651	0.137	231	15.8	0.66	1485
FLT-3PG-1701	1701	0.141	238	16.3	0.68	1530
FLT-3PG-1751	1751	0.145	245	16.8	0.70	1575
FLT-3PG-1801	1801	0.149	252	17.3	0.72	1620
FLT-3PG-1851	1851	0.153	259	17.8	0.74	1665
FLT-3PG-1900	1900	0.157	266	18.2	0.76	1710
FLT-3PG-1950	1950	0.161	273	18.7	0.78	1755
FLT-3PG-2000	2000	0.165	280	19.2	0.80	1800
FLT-3PG-2050	2050	0.169	287	19.7	0.82	1845
FLT-3PG-2100	2100	0.173	294	20.2	0.84	1890
FLT-3PG-2149	2149	0.177	301	20.6	0.86	1935
FLT-3PG-2199	2199	0.181	308	21.1	0.88	1980
FLT-3PG-2249	2249	0.185	315	21.6	0.90	2025
FLT-3PG-2299	2299	0.189	322	22.1	0.92	2070
FLT-3PG-2349	2349	0.193	329	22.6	0.94	2115
FLT-3PG-2398	2398	0.197	336	23.0	0.96	2160
FLT-3PG-2448	2448	0.201	343	23.5	0.98	2205
FLT-3PG-2498	2498	0.205	350	24.0	1.00	2250
FLT-3PG-2548	2548	0.209	357	24.5	1.02	2295
FLT-3PG-2598	2598	0.213	364	25.0	1.04	2340
FLT-3PG-2647	2647	0.217	371	25.4	1.06	2385
FLT-3PG-2697	2697	0.221	378	25.9	1.08	2430
FLT-3PG-2747	2747	0.225	385	26.4	1.10	2475
FLT-3PG-2797	2797	0.229	392	26.9	1.12	2520
FLT-3PG-2847	2847	0.233	399	27.4	1.14	2565
FLT-3PG-2896	2896	0.237	406	27.8	1.16	2610
FLT-3PG-2946	2946	0.241	413	28.3	1.18	2655
FLT-3PG-2996	2996	0.245	420	28.8	1.20	2700
FLT-3PG-3046	3046	0.249	427	29.3	1.22	2745
FLT-3PG-3096	3096	0.253	434	29.8	1.24	2790
FLT-3PG-3145	3145	0.257	441	30.2	1.26	2835
FLT-3PG-3195	3195	0.261	448	30.7	1.28	2880
FLT-3PG-3245	3245	0.265	455	31.2	1.30	2925

Reference	Length (mm)	Weight (kg)	No. of LED	Watts (W)	Amps (A)	Luminous flux (lm)
FLT-3PG-3295	3295	0.269	462	31.7	1.32	2970
FLT-3PG-3345	3345	0.273	469	32.2	1.34	3015
FLT-3PG-3394	3394	0.277	476	32.6	1.36	3060
FLT-3PG-3444	3444	0.281	483	33.1	1.38	3105
FLT-3PG-3494	3494	0.285	490	33.6	1.40	3150
FLT-3PG-3544	3544	0.289	497	34.1	1.42	3195
FLT-3PG-3594	3594	0.293	504	34.6	1.44	3240
FLT-3PG-3643	3643	0.297	511	35.0	1.46	3285
FLT-3PG-3693	3693	0.301	518	35.5	1.48	3330
FLT-3PG-3743	3743	0.305	525	36.0	1.50	3375
FLT-3PG-3793	3793	0.309	532	36.5	1.52	3420
FLT-3PG-3843	3843	0.313	539	37.0	1.54	3465
FLT-3PG-3892	3892	0.317	546	37.4	1.56	3510
FLT-3PG-3942	3942	0.321	553	37.9	1.58	3555
FLT-3PG-3992	3992	0.325	560	38.4	1.60	3600
FLT-3PG-4042	4042	0.329	567	38.9	1.62	3645
FLT-3PG-4092	4092	0.333	574	39.4	1.64	3690
FLT-3PG-4141	4141	0.337	581	39.8	1.66	3735
FLT-3PG-4191	4191	0.341	588	40.3	1.68	3780
FLT-3PG-4241	4241	0.345	595	40.8	1.70	3825
FLT-3PG-4291	4291	0.349	602	41.3	1.72	3870
FLT-3PG-4341	4341	0.353	609	41.8	1.74	3915
FLT-3PG-4390	4390	0.357	616	42.2	1.76	3960
FLT-3PG-4440	4440	0.361	623	42.7	1.78	4005
FLT-3PG-4490	4490	0.365	630	43.2	1.80	4050
FLT-3PG-4540	4540	0.369	637	43.7	1.82	4095
FLT-3PG-4590	4590	0.373	644	44.2	1.84	4140
FLT-3PG-4639	4639	0.377	651	44.6	1.86	4185
FLT-3PG-4689	4689	0.381	658	45.1	1.88	4230
FLT-3PG-4739	4739	0.385	665	45.6	1.90	4275
FLT-3PG-4789	4789	0.389	672	46.1	1.92	4320
FLT-3PG-4839	4839	0.393	679	46.6	1.94	4365
FLT-3PG-4888	4888	0.397	686	47.0	1.96	4410
FLT-3PG-4938	4938	0.401	693	47.5	1.98	4455
FLT-3PG-4988	4988	0.405	700	48.0	2.00	4500
FLT-3PG-5038	5038	0.409	707	48.5	2.02	4545
FLT-3PG-5088	5088	0.413	714	49.0	2.04	4590
FLT-3PG-5137	5137	0.417	721	49.4	2.06	4635
FLT-3PG-5187	5187	0.421	728	49.9	2.08	4680
FLT-3PG-5237	5237	0.425	735	50.4	2.10	4725
FLT-3PG-5287	5287	0.429	742	50.9	2.12	4770
FLT-3PG-5337	5337	0.433	749	51.4	2.14	4815
FLT-3PG-5386	5386	0.437	756	51.8	2.16	4860
FLT-3PG-5436	5436	0.441	763	52.3	2.18	4905
FLT-3PG-5486	5486	0.445	770	52.8	2.20	4950
FLT-3PG-5536	5536	0.449	777	53.3	2.22	4995
FLT-3PG-5586	5586	0.453	784	53.8	2.24	5040
FLT-3PG-5635	5635	0.457	791	54.2	2.26	5085
FLT-3PG-5685	5685	0.461	798	54.7	2.28	5130
FLT-3PG-5735	5735	0.465	805	55.2	2.30	5175
FLT-3PG-5785	5785	0.469	812	55.7	2.32	5220
FLT-3PG-5835	5835	0.473	819	56.2	2.34	5265
FLT-3PG-5884	5884	0.477	826	56.6	2.36	5310
FLT-3PG-5934	5934	0.481	833	57.1	2.38	5355
FLT-3PG-5984	5984	0.485	840	57.6	2.40	5400
FLT-3PG-6034	6034	0.489	847	58.1	2.42	5445
FLT-3PG-6084	6084	0.493	854	58.6	2.44	5490
FLT-3PG-6133	6133	0.497	861	59.0	2.46	5535
FLT-3PG-6183	6183	0.501	868	59.5	2.48	5580
FLT-3PG-6233	6233	0.505	875	60.0	2.50	5625
FLT-3PG-6283	6283	0.509	882	60.5	2.52	5670
FLT-3PG-6333	6333	0.513	889	61.0	2.54	5715
FLT-3PG-6382	6382	0.517	896	61.4	2.56	5760
FLT-3PG-6432	6432	0.521	903	61.9	2.58	5805
FLT-3PG-6482	6482	0.525	910	62.4	2.60	5850

* Maximum standard length 6.5m. For longer specification, please contact us.

Option parts

Mounting bracket FLT-CR

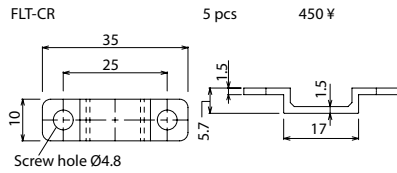

Mounting clip FLT-RLC

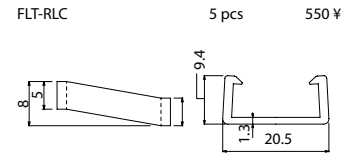

Mounting rail FLT-RL



FLT-RL-500	470mm	1 pcs	1500 ¥
FLT-RL-1000	970mm	1 pcs	1700 ¥
FLT-RL-1500	1470mm	1 pcs	2000 ¥
FLT-RL-2900	1970mm	1 pcs	2500 ¥

In case of FLT-RL-500/1000 you shall use 5 mounting clip.
In case of FLT-RL-1500/2000 you shall use 10 mounting clip.

Cap FLT-C

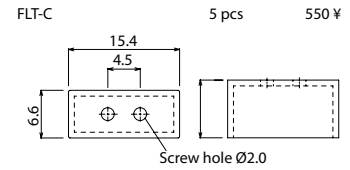

Jumper cable SMX



SMX-80	80 mm	1 pcs	500 ¥
SMX-200	200 mm	1 pcs	500 ¥
SMX-300	300 mm	1 pcs	500 ¥
SMX-400	400 mm	1 pcs	600 ¥

SMX-500	500 mm	1 pcs	600 ¥
SMX-1000	1000 mm	1 pcs	600 ¥
SMX-2000	2000 mm	1 pcs	1200 ¥
SMX-3000	3000 mm	1 pcs	1800 ¥
SMX-4000	4000 mm	1 pcs	2400 ¥

Power supply out cable DGC



DGC-1	500mm	1 connector	700 ¥
DGC-2	500mm	2 connectors	900 ¥
DGC-3	500mm	3 connectors	1100 ¥
DGC-4	500mm	4 connectors	1300 ¥

Power supply in lead cable DGN



DGN-2500	2500mm	1 pcs	1350 ¥
----------	--------	-------	--------

Power supply unit (OSRAM OT)



OT30/100-200-24-T	30W	1 pcs	Open price
OT60/100-200-24-T	60W	1 pcs	Open price
OT90/100-200-24-T	90W	1 pcs	Open price
OT150/100-200-24-T	150W	1 pcs	Open price

Input AC90~240V, output DC24V.
Comply with CE, UL, PSE standards. IP 66 water proof rating.

DC 24V dimmer FMC-24S/R



FMC-24S/R	1 pcs	34500 ¥
-----------	-------	---------

Available in 3 colors:



DC 24V simple dimmer FSD-24



FSD-24	1 pcs	9900 ¥
--------	-------	--------

Installation / Power supply connection

Mounting rail installation

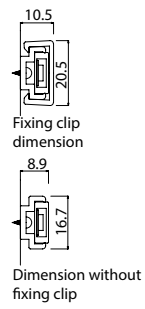
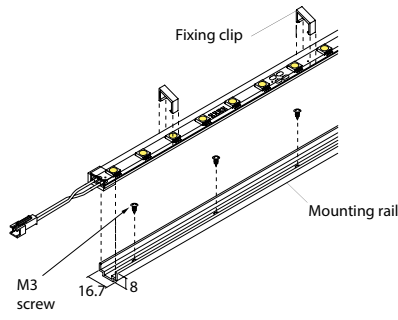

Mounting bracket installation

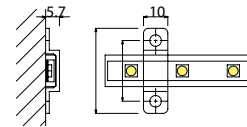
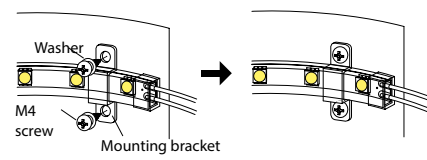

* Please always use washers when fixing the brackets.

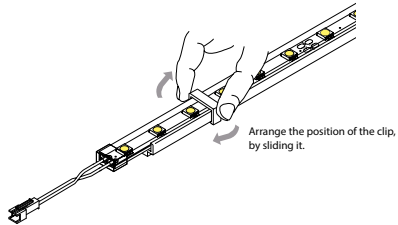

Cutting the fixture

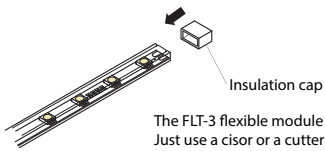

The FLT-3 flexible module can be cut at every section of 49.8 mm. Just use a cisor or a cutter to cut on indicated mark on the fixture.

Installation / Power supply connection

