



FKK

LED EMERGENCY LIGHTING

CATALOG 2022

2 in 1 Lighting solution

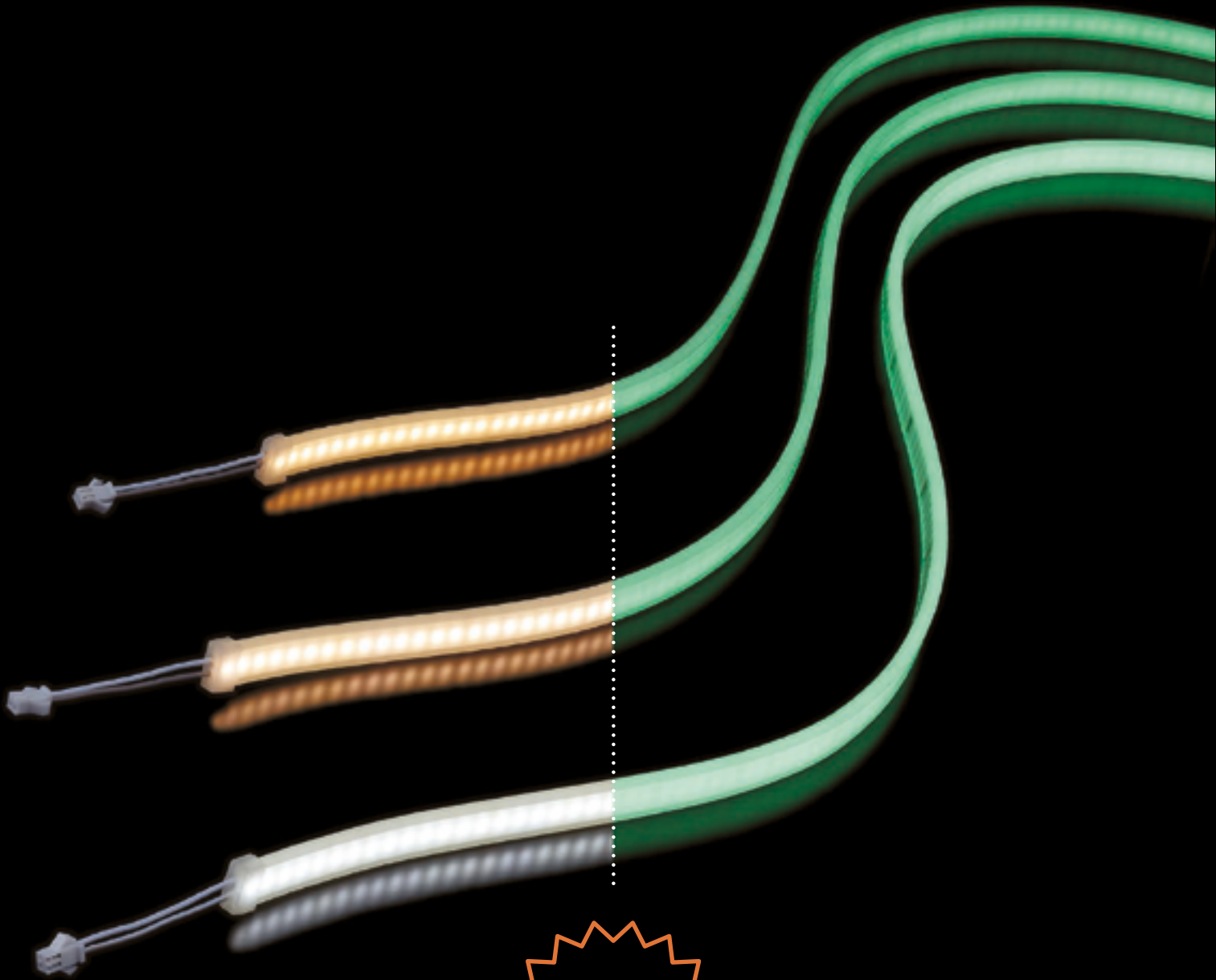

Normal LED lighting
Normal condition

Blackout

During blackout
No electricity

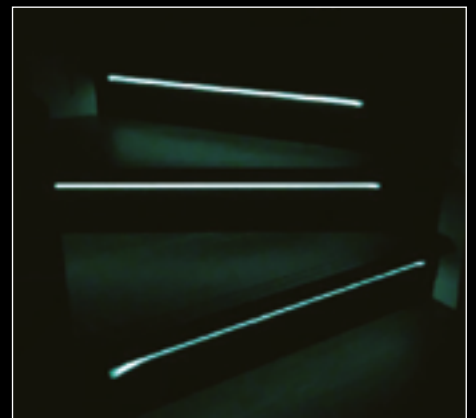

Features

- 2 in 1 LED tape light: normal light and emergency light. During normal time works as conventional LED light and during blackout event functions as emergency light.
- New phosphorescence technology allow light to glow and be visible in the dark even after 10 hours.
- The LED mounted on the product ensures phosphorescence and instant phosphorescence when power is cut off. No need of battery during blackout.
- IP 65~67 waterproof, dustproof. Employs phosphorescent pigment with excellent water resistance.
- The main body uses silicone with excellent electrical insulation, heat resistance, weather resistance, and fatigue resistance.
- Patented product and production method.
- Product certified and recommended by Japanese Disaster Prevention Safety Association.

New concept of emergency light

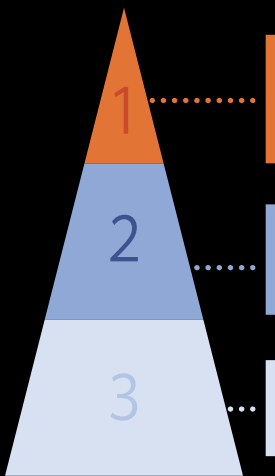

Just enough light to save life

The goal of this light is to provide just enough visible guiding light in case of disaster or blackout event in an affordable product concept. How much life can we save by expanding this new form of lighting and just by providing visible enough light to allow peoples to escape from the dark.

Lighting the dark

It can be complicated to set up emergency light in dark and confined places such as tunnel, underground parking, elevator, escalator, emergency stair, etc. This light is easy to install and won't be redundant with usual lighting.

A plus in all configuration

This light can be use not only in harzarduous places but also in every homes, rooms and living interiors making these environment more secure and resilient in case of blackout.

Next generation phosphorescent material



Conventional phosphorescent pigments are weak against water as they chemically change even when immersed in water for a short period of time leading to degradation of phosphorescence property.

The new generation of phosphorescent pigments used in this product is characterized by no chemical changes even during long-term water immersion.

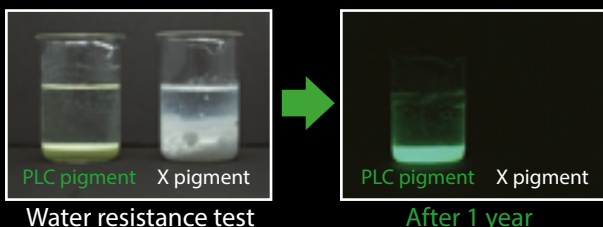

Furthermore, we succeeded in improving the light-emitting capacity and water-resistance by a special patented molding method.

The result is a new light with long lasting phosphorescent property and high glowing effect in all conditions.

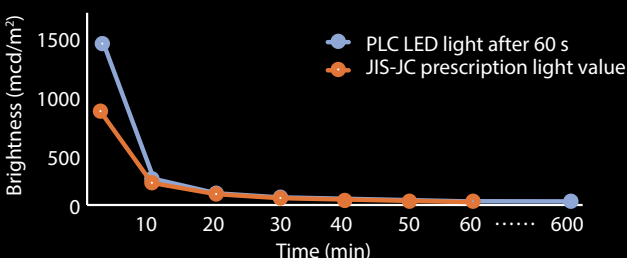

Discernable in the dark even after 10 hours

10 hours after the power is turn off, with a brightness of 3 mcd/m², the phosphorescent glowing light still visible enough to be use as escape route emergency light according to international standards (German DIN67510 or Japan JIS Z 9107 standard).

Flexible Module Indoor lighting





FLT-3PG

LED Flexible Module



- Built-in **phosphorescence** function, produce bright light even when the power is off
- Visible in the dark even after 10 hours
- Up to 6.5 m standard length



FLT-3PG - 1004 - N - K

1 Fixture name : FLT-3PG= LED Flexible Module FLare Line PLC
 Length : 58mm~6482mm
 3 LED color : L25 = Light bulb (2500K)
 L27 = Light bulb (2700K)
 L30 = Light bulb (3000K)
 WW = Warm white (3500K)
 W = White (4000K)
 N = Neutral white (5000K)
 D = Daylight (6500K)
 None = standard/K = one end connector

4 Connector: None = standard/K = one end connector

Environment of use : indoor cove / display lighting
 Maximum length in series : 6.5m (6482mm) (longer possible upon request)
 Driver : DC 24V
 CRI: > 80 Ra

Color temperature CCT

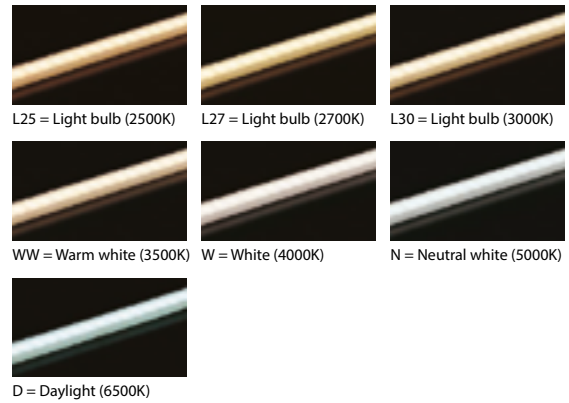

Photometric data

Measured fixture: FLT-3PG-1004-N

Light Intensity distribution

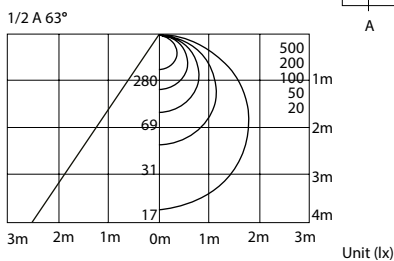

Candlepower Distribution

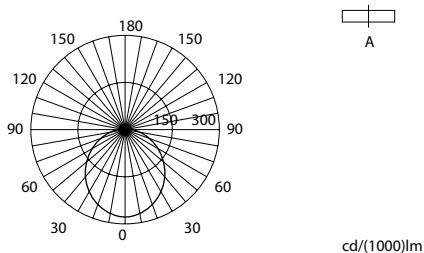

Dimensions

Unit (mm)

External dimension

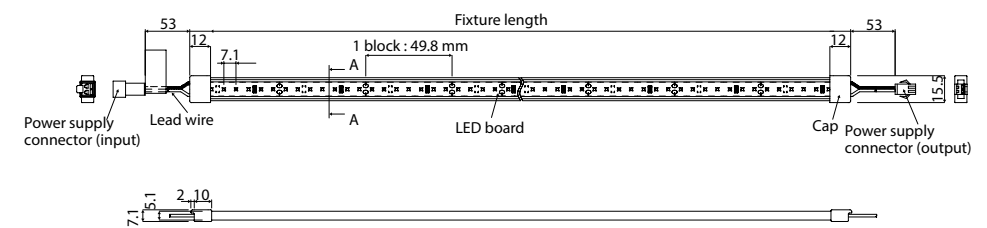

Cross sectional view A-A

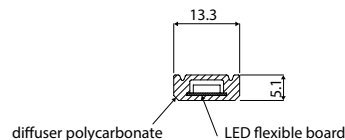

Connector dimension

Power supply in:

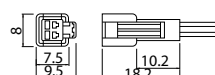

Power supply out:

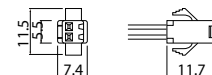

Order made sizes

Reference	Length (mm)	Weight (kg)	No. of LED	Watts (W)	Amps (A)	Luminous flux (lm)
FLT-3PG-58	58	0.009	7	0.5	0.02	45
FLT-3PG-108	108	0.013	14	1.0	0.04	90
FLT-3PG-157	157	0.017	21	1.4	0.06	135
FLT-3PG-207	207	0.021	28	1.9	0.08	180
FLT-3PG-257	257	0.025	35	2.4	0.10	225
FLT-3PG-307	307	0.029	42	2.9	0.12	270
FLT-3PG-357	357	0.033	49	3.4	0.14	315
FLT-3PG-406	406	0.037	56	3.8	0.16	360
FLT-3PG-456	456	0.041	63	4.3	0.18	405
FLT-3PG-506	506	0.045	70	4.8	0.20	450
FLT-3PG-556	556	0.049	77	5.3	0.22	495
FLT-3PG-606	606	0.053	84	5.8	0.24	540
FLT-3PG-655	655	0.057	91	6.2	0.26	585
FLT-3PG-705	705	0.061	98	6.7	0.28	630
FLT-3PG-755	755	0.065	105	7.2	0.30	675
FLT-3PG-805	805	0.069	112	7.7	0.32	720
FLT-3PG-855	855	0.073	119	8.2	0.34	765
FLT-3PG-904	904	0.077	126	8.6	0.36	810
FLT-3PG-954	954	0.081	133	9.1	0.38	855
FLT-3PG-1004	1004	0.085	140	9.6	0.40	900
FLT-3PG-1054	1054	0.089	147	10.1	0.42	945
FLT-3PG-1104	1104	0.093	154	10.6	0.44	990
FLT-3PG-1153	1153	0.097	161	11.0	0.46	1035
FLT-3PG-1203	1203	0.101	168	11.5	0.48	1080
FLT-3PG-1253	1253	0.105	175	12.0	0.50	1125
FLT-3PG-1303	1303	0.109	182	12.5	0.52	1170
FLT-3PG-1353	1353	0.113	189	13.0	0.54	1215
FLT-3PG-1402	1402	0.117	196	13.4	0.56	1260
FLT-3PG-1452	1452	0.121	203	13.9	0.58	1305
FLT-3PG-1502	1502	0.125	210	14.4	0.60	1350
FLT-3PG-1552	1552	0.129	217	14.9	0.62	1395
FLT-3PG-1602	1602	0.133	224	15.4	0.64	1440
FLT-3PG-1651	1651	0.137	231	15.8	0.66	1485
FLT-3PG-1701	1701	0.141	238	16.3	0.68	1530
FLT-3PG-1751	1751	0.145	245	16.8	0.70	1575
FLT-3PG-1801	1801	0.149	252	17.3	0.72	1620
FLT-3PG-1851	1851	0.153	259	17.8	0.74	1665
FLT-3PG-1900	1900	0.157	266	18.2	0.76	1710
FLT-3PG-1950	1950	0.161	273	18.7	0.78	1755
FLT-3PG-2000	2000	0.165	280	19.2	0.80	1800
FLT-3PG-2050	2050	0.169	287	19.7	0.82	1845
FLT-3PG-2100	2100	0.173	294	20.2	0.84	1890
FLT-3PG-2149	2149	0.177	301	20.6	0.86	1935
FLT-3PG-2199	2199	0.181	308	21.1	0.88	1980
FLT-3PG-2249	2249	0.185	315	21.6	0.90	2025
FLT-3PG-2299	2299	0.189	322	22.1	0.92	2070
FLT-3PG-2349	2349	0.193	329	22.6	0.94	2115
FLT-3PG-2398	2398	0.197	336	23.0	0.96	2160
FLT-3PG-2448	2448	0.201	343	23.5	0.98	2205
FLT-3PG-2498	2498	0.205	350	24.0	1.00	2250
FLT-3PG-2548	2548	0.209	357	24.5	1.02	2295
FLT-3PG-2598	2598	0.213	364	25.0	1.04	2340
FLT-3PG-2647	2647	0.217	371	25.4	1.06	2385
FLT-3PG-2697	2697	0.221	378	25.9	1.08	2430
FLT-3PG-2747	2747	0.225	385	26.4	1.10	2475
FLT-3PG-2797	2797	0.229	392	26.9	1.12	2520
FLT-3PG-2847	2847	0.233	399	27.4	1.14	2565
FLT-3PG-2896	2896	0.237	406	27.8	1.16	2610
FLT-3PG-2946	2946	0.241	413	28.3	1.18	2655
FLT-3PG-2996	2996	0.245	420	28.8	1.20	2700
FLT-3PG-3046	3046	0.249	427	29.3	1.22	2745
FLT-3PG-3096	3096	0.253	434	29.8	1.24	2790
FLT-3PG-3145	3145	0.257	441	30.2	1.26	2835
FLT-3PG-3195	3195	0.261	448	30.7	1.28	2880
FLT-3PG-3245	3245	0.265	455	31.2	1.30	2925

Reference	Length (mm)	Weight (kg)	No. of LED	Watts (W)	Amps (A)	Luminous flux (lm)
FLT-3PG-3295	3295	0.269	462	31.7	1.32	2970
FLT-3PG-3345	3345	0.273	469	32.2	1.34	3015
FLT-3PG-3394	3394	0.277	476	32.6	1.36	3060
FLT-3PG-3444	3444	0.281	483	33.1	1.38	3105
FLT-3PG-3494	3494	0.285	490	33.6	1.40	3150
FLT-3PG-3544	3544	0.289	497	34.1	1.42	3195
FLT-3PG-3594	3594	0.293	504	34.6	1.44	3240
FLT-3PG-3643	3643	0.297	511	35.0	1.46	3285
FLT-3PG-3693	3693	0.301	518	35.5	1.48	3330
FLT-3PG-3743	3743	0.305	525	36.0	1.50	3375
FLT-3PG-3793	3793	0.309	532	36.5	1.52	3420
FLT-3PG-3843	3843	0.313	539	37.0	1.54	3465
FLT-3PG-3892	3892	0.317	546	37.4	1.56	3510
FLT-3PG-3942	3942	0.321	553	37.9	1.58	3555
FLT-3PG-3992	3992	0.325	560	38.4	1.60	3600
FLT-3PG-4042	4042	0.329	567	38.9	1.62	3645
FLT-3PG-4092	4092	0.333	574	39.4	1.64	3690
FLT-3PG-4141	4141	0.337	581	39.8	1.66	3735
FLT-3PG-4191	4191	0.341	588	40.3	1.68	3780
FLT-3PG-4241	4241	0.345	595	40.8	1.70	3825
FLT-3PG-4291	4291	0.349	602	41.3	1.72	3870
FLT-3PG-4341	4341	0.353	609	41.8	1.74	3915
FLT-3PG-4390	4390	0.357	616	42.2	1.76	3960
FLT-3PG-4440	4440	0.361	623	42.7	1.78	4005
FLT-3PG-4490	4490	0.365	630	43.2	1.80	4050
FLT-3PG-4540	4540	0.369	637	43.7	1.82	4095
FLT-3PG-4590	4590	0.373	644	44.2	1.84	4140
FLT-3PG-4639	4639	0.377	651	44.6	1.86	4185
FLT-3PG-4689	4689	0.381	658	45.1	1.88	4230
FLT-3PG-4739	4739	0.385	665	45.6	1.90	4275
FLT-3PG-4789	4789	0.389	672	46.1	1.92	4320
FLT-3PG-4839	4839	0.393	679	46.6	1.94	4365
FLT-3PG-4888	4888	0.397	686	47.0	1.96	4410
FLT-3PG-4938	4938	0.401	693	47.5	1.98	4455
FLT-3PG-4988	4988	0.405	700	48.0	2.00	4500
FLT-3PG-5038	5038	0.409	707	48.5	2.02	4545
FLT-3PG-5088	5088	0.413	714	49.0	2.04	4590
FLT-3PG-5137	5137	0.417	721	49.4	2.06	4635
FLT-3PG-5187	5187	0.421	728	49.9	2.08	4680
FLT-3PG-5237	5237	0.425	735	50.4	2.10	4725
FLT-3PG-5287	5287	0.429	742	50.9	2.12	4770
FLT-3PG-5337	5337	0.433	749	51.4	2.14	4815
FLT-3PG-5386	5386	0.437	756	51.8	2.16	4860
FLT-3PG-5436	5436	0.441	763	52.3	2.18	4905
FLT-3PG-5486	5486	0.445	770	52.8	2.20	4950
FLT-3PG-5536	5536	0.449	777	53.3	2.22	4995
FLT-3PG-5586	5586	0.453	784	53.8	2.24	5040
FLT-3PG-5635	5635	0.457	791	54.2	2.26	5085
FLT-3PG-5685	5685	0.461	798	54.7	2.28	5130
FLT-3PG-5735	5735	0.465	805	55.2	2.30	5175
FLT-3PG-5785	5785	0.469	812	55.7	2.32	5220
FLT-3PG-5835	5835	0.473	819	56.2	2.34	5265
FLT-3PG-5884	5884	0.477	826	56.6	2.36	5310
FLT-3PG-5934	5934	0.481	833	57.1	2.38	5355
FLT-3PG-5984	5984	0.485	840	57.6	2.40	5400
FLT-3PG-6034	6034	0.489	847	58.1	2.42	5445
FLT-3PG-6084	6084	0.493	854	58.6	2.44	5490
FLT-3PG-6133	6133	0.497	861	59.0	2.46	5535
FLT-3PG-6183	6183	0.501	868	59.5	2.48	5580
FLT-3PG-6233	6233	0.505	875	60.0	2.50	5625
FLT-3PG-6283	6283	0.509	882	60.5	2.52	5670
FLT-3PG-6333	6333	0.513	889	61.0	2.54	5715
FLT-3PG-6382	6382	0.517	896	61.4	2.56	5760
FLT-3PG-6432	6432	0.521	903	61.9	2.58	5805
FLT-3PG-6482	6482	0.525	910	62.4	2.60	5850

* Maximum standard length 6.5m. For longer specification, please contact us.

Option parts

Mounting bracket FLT-CR

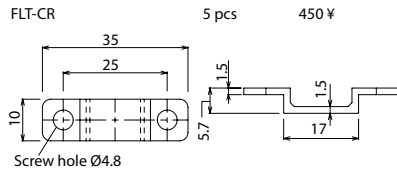

Mounting clip FLT-RLC

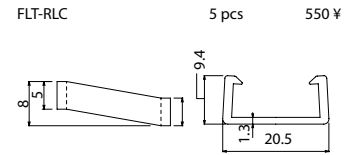

Mounting rail FLT-RL



FLT-RL-500	470mm	1 pcs	1500 ¥
FLT-RL-1000	970mm	1 pcs	1700 ¥
FLT-RL-1500	1470mm	1 pcs	2000 ¥
FLT-RL-2900	1970mm	1 pcs	2500 ¥

In case of FLK-RL-500/1000 you shall usen 5 mounting clip.
In case of FLK-RL-1500/2000 you shall usen 10 mounting clip.

Cap FLT-C

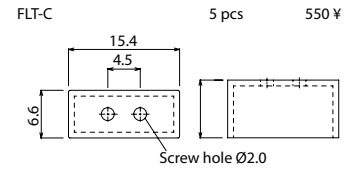

Jumper cable SMX



SMX-80	80 mm	1 pcs	500 ¥
SMX-200	200 mm	1 pcs	500 ¥
SMX-300	300 mm	1 pcs	500 ¥
SMX-400	400 mm	1 pcs	600 ¥

SMX-500	500 mm	1 pcs	600 ¥
SMX-1000	1000 mm	1 pcs	600 ¥
SMX-2000	2000 mm	1 pcs	1200 ¥
SMX-3000	3000 mm	1 pcs	1800 ¥
SMX-4000	4000 mm	1 pcs	2400 ¥

Power supply out cable DGC



DGC-1	500mm	1 connector	700 ¥
DGC-2	500mm	2 connectors	900 ¥
DGC-3	500mm	3 connectors	1100 ¥
DGC-4	500mm	4 connectors	1300 ¥

Power supply in lead cable DGN



DGN-2500	2500mm	1 pcs	1350 ¥
----------	--------	-------	--------

Power supply unit (OSRAM OT)



OT30/100-200-24-T	30W	1 pcs	Open price
OT60/100-200-24-T	60W	1 pcs	Open price
OT90/100-200-24-T	90W	1 pcs	Open price
OT150/100-200-24-T	150W	1 pcs	Open price

Input AC90~240V, output DC24V.
Comply with CE, UL, PSE standards. IP 66 water proof rating.

DC 24V dimmer FMC-24S/R



FMC-24S/R	1 pcs	34500 ¥
-----------	-------	---------

Available in 3 colors:



DC 24V simple dimmer FSD-24



FSD-24	1 pcs	9900 ¥
--------	-------	--------

Installation / Power supply connection

Mounting rail installation

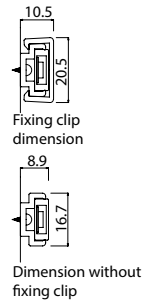
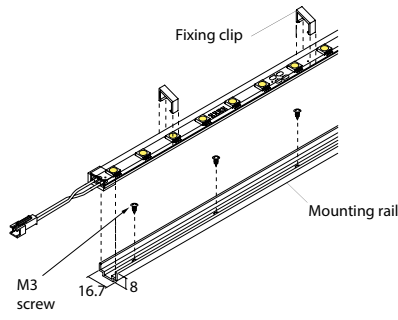

Mounting bracket installation

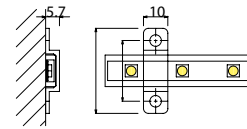
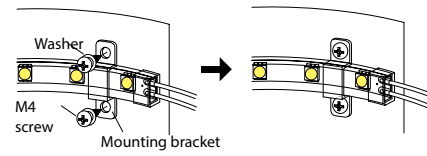

* Please always use washers when fixing the brackets.

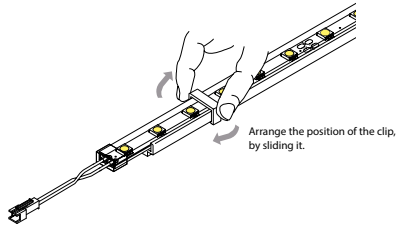

Cutting the fixture

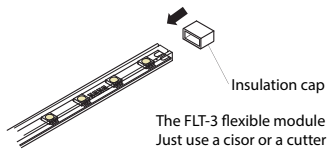

The FLT-3 flexible module can be cut at every section of 49.8 mm. Just use a cisor or a cutter to cut on indicated mark on the fixture.

Installation / Power supply connection

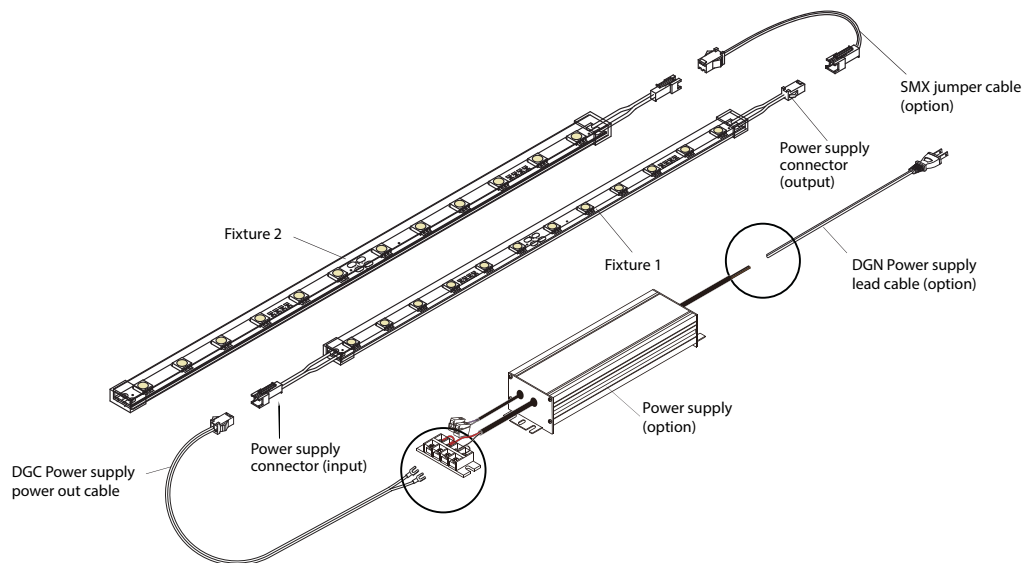

Flexible Module Waterproof / Dustproof





FLT-3PGA

LED Flexible Module



- Built-in phosphorescence function, produce bright light even when the power is off
- Visible in the dark even after 10 hours
- Up to 6.5 m standard length
- IP 65~67 waterproof

FLT-3PGA - 1016 - N - K

1	2	3	4
1 Fixture name :		FLT-3PGA= LED Flexible Module FLare Line PLC Outdoor	
Length :		70mm~6494mm	
3 LED color :		L25 = Light bulb (2500K) L27 = Light bulb (2700K) L30 = Light bulb (3000K) WW = Warm white (3500K) W = White (4000K) N = Neutral white (5000K) D = Daylight (6500K)	
4 Connector:		None = standard/K = one end connector	
Environment of use :		outdoor accent / architectural lighting /IP65~67	
Maximum length in series :		6.5m (6494mm) (longer possible upon request)	
Driver :		DC 24V	
CRI:		> 80 Ra	

Color temperature CCT

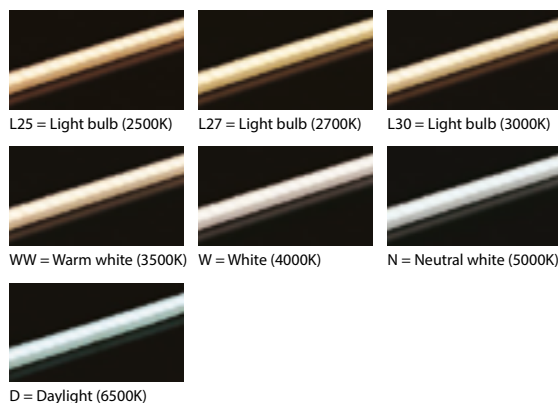

Photometric data

Measured fixture: FLT-3PGA-1016-N

Light Intensity distribution

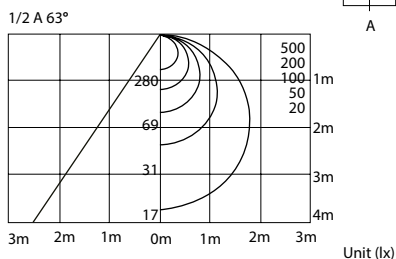

Candlepower Distribution

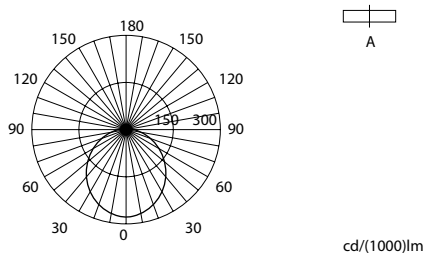

Dimensions

Unit (mm)

External dimension

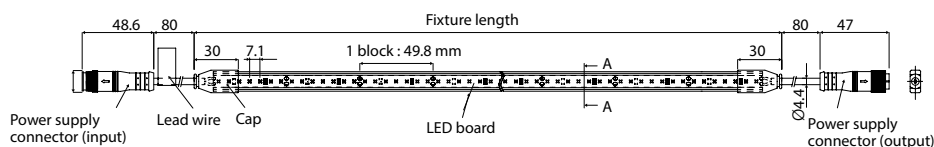

Cross sectional view A-A

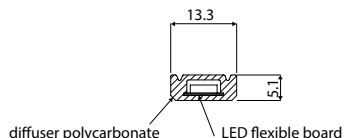

Order made sizes

Reference	Length (mm)	Weight (kg)	No. of LED	Watts (W)	Amps (A)	Luminous flux (lm)
FLT-3PGA-70	70	0.024	7	0.5	0.02	45
FLT-3PGA-120	120	0.049	14	1.0	0.04	90
FLT-3PGA-169	169	0.073	21	1.4	0.06	135
FLT-3PGA-219	219	0.098	28	1.9	0.08	180
FLT-3PGA-269	269	0.122	35	2.4	0.10	225
FLT-3PGA-319	319	0.146	42	2.9	0.12	270
FLT-3PGA-369	369	0.171	49	3.4	0.14	315
FLT-3PGA-418	418	0.195	56	3.8	0.16	360
FLT-3PGA-468	468	0.220	63	4.3	0.18	405
FLT-3PGA-518	518	0.244	70	4.8	0.20	450
FLT-3PGA-568	568	0.268	77	5.3	0.22	495
FLT-3PGA-618	618	0.293	84	5.8	0.24	540
FLT-3PGA-667	667	0.317	91	6.2	0.26	585
FLT-3PGA-717	717	0.342	98	6.7	0.28	630
FLT-3PGA-767	767	0.366	105	7.2	0.30	675
FLT-3PGA-817	817	0.390	112	7.7	0.32	720
FLT-3PGA-867	867	0.415	119	8.2	0.34	765
FLT-3PGA-916	916	0.439	126	8.6	0.36	810
FLT-3PGA-966	966	0.464	133	9.1	0.38	855
FLT-3PGA-1016	1016	0.488	140	9.6	0.40	900
FLT-3PGA-1066	1066	0.512	147	10.1	0.42	945
FLT-3PGA-1116	1116	0.537	154	10.6	0.44	990
FLT-3PGA-1165	1165	0.561	161	11.0	0.46	1035
FLT-3PGA-1215	1215	0.586	168	11.5	0.48	1080
FLT-3PGA-1265	1265	0.610	175	12.0	0.50	1125
FLT-3PGA-1315	1315	0.634	182	12.5	0.52	1170
FLT-3PGA-1365	1365	0.659	189	13.0	0.54	1215
FLT-3PGA-1414	1414	0.683	196	13.4	0.56	1260
FLT-3PGA-1464	1464	0.708	203	13.9	0.58	1305
FLT-3PGA-1514	1514	0.732	210	14.4	0.60	1350
FLT-3PGA-1564	1564	0.756	217	14.9	0.62	1395
FLT-3PGA-1614	1614	0.781	224	15.4	0.64	1440
FLT-3PGA-1663	1663	0.805	231	15.8	0.66	1485
FLT-3PGA-1713	1713	0.830	238	16.3	0.68	1530
FLT-3PGA-1763	1763	0.854	245	16.8	0.70	1575
FLT-3PGA-1813	1813	0.878	252	17.3	0.72	1620
FLT-3PGA-1863	1863	0.903	259	17.8	0.74	1665
FLT-3PGA-1912	1912	0.927	266	18.2	0.76	1710
FLT-3PGA-1962	1962	0.952	273	18.7	0.78	1755
FLT-3PGA-2012	2012	0.976	280	19.2	0.80	1800
FLT-3PGA-2062	2062	1.000	287	19.7	0.82	1845
FLT-3PGA-2112	2112	1.025	294	20.2	0.84	1890
FLT-3PGA-2161	2161	1.049	301	20.6	0.86	1935
FLT-3PGA-2211	2211	1.074	308	21.1	0.88	1980
FLT-3PGA-2261	2261	1.098	315	21.6	0.90	2025
FLT-3PGA-2311	2311	1.122	322	22.1	0.92	2070
FLT-3PGA-2361	2361	1.147	329	22.6	0.94	2115
FLT-3PGA-2410	2410	1.171	336	23.0	0.96	2160
FLT-3PGA-2460	2460	1.196	343	23.5	0.98	2205
FLT-3PGA-2510	2510	1.220	350	24.0	1.00	2250
FLT-3PGA-2560	2560	1.244	357	24.5	1.02	2295
FLT-3PGA-2610	2610	1.269	364	25.0	1.04	2340
FLT-3PGA-2659	2659	1.293	371	25.4	1.06	2385
FLT-3PGA-2709	2709	1.318	378	25.9	1.08	2430
FLT-3PGA-2759	2759	1.342	385	26.4	1.10	2475
FLT-3PGA-2809	2809	1.366	392	26.9	1.12	2520
FLT-3PGA-2859	2859	1.391	399	27.4	1.14	2565
FLT-3PGA-2908	2908	1.415	406	27.8	1.16	2610
FLT-3PGA-2958	2958	1.440	413	28.3	1.18	2655
FLT-3PGA-3008	3008	1.464	420	28.8	1.20	2700
FLT-3PGA-3058	3058	1.488	427	29.3	1.22	2745
FLT-3PGA-3108	3108	1.513	434	29.8	1.24	2790
FLT-3PGA-3157	3157	1.537	441	30.2	1.26	2835
FLT-3PGA-3207	3207	1.562	448	30.7	1.28	2880
FLT-3PGA-3257	3257	1.586	455	31.2	1.30	2925

Reference	Length (mm)	Weight (kg)	No. of LED	Watts (W)	Amps (A)	Luminous flux (lm)
FLT-3PGA-3307	3307	1.610	462	31.7	1.32	2970
FLT-3PGA-3357	3357	1.635	469	32.2	1.34	3015
FLT-3PGA-3406	3406	1.659	476	32.6	1.36	3060
FLT-3PGA-3456	3456	1.684	483	33.1	1.38	3105
FLT-3PGA-3506	3506	1.708	490	33.6	1.40	3150
FLT-3PGA-3556	3556	1.732	497	34.1	1.42	3195
FLT-3PGA-3606	3606	1.757	504	34.6	1.44	3240
FLT-3PGA-3655	3655	1.781	511	35.0	1.46	3285
FLT-3PGA-3705	3705	1.806	518	35.5	1.48	3330
FLT-3PGA-3755	3755	1.830	525	36.0	1.50	3375
FLT-3PGA-3805	3805	1.854	532	36.5	1.52	3420
FLT-3PGA-3855	3855	1.879	539	37.0	1.54	3465
FLT-3PGA-3904	3904	1.903	546	37.4	1.56	3510
FLT-3PGA-3954	3954	1.928	553	37.9	1.58	3555
FLT-3PGA-4004	4004	1.952	560	38.4	1.60	3600
FLT-3PGA-4054	4054	1.976	567	38.9	1.62	3645
FLT-3PGA-4104	4104	2.001	574	39.4	1.64	3690
FLT-3PGA-4153	4153	2.025	581	39.8	1.66	3735
FLT-3PGA-4203	4203	2.050	588	40.3	1.68	3780
FLT-3PGA-4253	4253	2.074	595	40.8	1.70	3825
FLT-3PGA-4303	4303	2.098	602	41.3	1.72	3870
FLT-3PGA-4353	4353	2.123	609	41.8	1.74	3915
FLT-3PGA-4402	4402	2.147	616	42.2	1.76	3960
FLT-3PGA-4452	4452	2.172	623	42.7	1.78	4005
FLT-3PGA-4502	4502	2.196	630	43.2	1.80	4050
FLT-3PGA-4552	4552	2.220	637	43.7	1.82	4095
FLT-3PGA-4602	4602	2.245	644	44.2	1.84	4140
FLT-3PGA-4651	4651	2.269	651	44.6	1.86	4185
FLT-3PGA-4701	4701	2.294	658	45.1	1.88	4230
FLT-3PGA-4751	4751	2.318	665	45.6	1.90	4275
FLT-3PGA-4801	4801	2.342	672	46.1	1.92	4320
FLT-3PGA-4851	4851	2.367	679	46.6	1.94	4365
FLT-3PGA-4900	4900	2.391	686	47.0	1.96	4410
FLT-3PGA-4950	4950	2.416	693	47.5	1.98	4455
FLT-3PGA-5000	5000	2.440	700	48.0	2.00	4500
FLT-3PGA-5050	5050	2.464	707	48.5	2.02	4545
FLT-3PGA-5100	5100	2.489	714	49.0	2.04	4590
FLT-3PGA-5149	5149	2.513	721	49.4	2.06	4635
FLT-3PGA-5199	5199	2.538	728	49.9	2.08	4680
FLT-3PGA-5249	5249	2.562	735	50.4	2.10	4725
FLT-3PGA-5299	5299	2.586	742	50.9	2.12	4770
FLT-3PGA-5349	5349	2.611	749	51.4	2.14	4815
FLT-3PGA-5398	5398	2.635	756	51.8	2.16	4860
FLT-3PGA-5448	5448	2.660	763	52.3	2.18	4905
FLT-3PGA-5498	5498	2.684	770	52.8	2.20	4950
FLT-3PGA-5548	5548	2.708	777	53.3	2.22	4995
FLT-3PGA-5598	5598	2.733	784	53.8	2.24	5040
FLT-3PGA-5647	5647	2.757	791	54.2	2.26	5085
FLT-3PGA-5697	5697	2.782	798	54.7	2.28	5130
FLT-3PGA-5747	5747	2.806	805	55.2	2.30	5175
FLT-3PGA-5797	5797	2.830	812	55.7	2.32	5220
FLT-3PGA-5847	5847	2.855	819	56.2	2.34	5265
FLT-3PGA-5896	5896	2.879	826	56.6	2.36	5310
FLT-3PGA-5946	5946	2.904	833	57.1	2.38	5355
FLT-3PGA-5996	5996	2.928	840	57.6	2.40	5400
FLT-3PGA-6046	6046	2.952	847	58.1	2.42	5445
FLT-3PGA-6096	6096	2.977	854	58.6	2.44	5490
FLT-3PGA-6145	6145	3.001	861	59.0	2.46	5535
FLT-3PGA-6195	6195	3.026	868	59.5	2.48	5580
FLT-3PGA-6245	6245	3.050	875	60.0	2.50	5625
FLT-3PGA-6295	6295	3.074	882	60.5	2.52	5670
FLT-3PGA-6345	6345	3.099	889	61.0	2.54	5715
FLT-3PGA-6394	6394	3.123	896	61.4	2.56	5760
FLT-3PGA-6444	6444	3.148	903	61.9	2.58	5805
FLT-3PGA-6494	6494	3.172	910	62.4	2.60	5850

* Maximum standard length 6.5m. For longer specification, please contact us.

Option parts

Mounting bracket FLT-CR

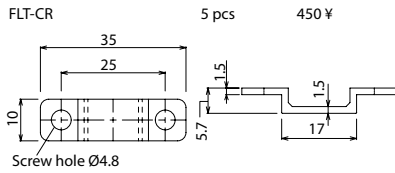

Mounting clip FLT-RLC

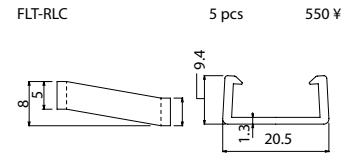

Mounting rail FLT-RL



FLT-RL-500	470mm	1 pcs	1500 ¥
FLT-RL-1000	970mm	1 pcs	1700 ¥
FLT-RL-1500	1470mm	1 pcs	2000 ¥
FLT-RL-2900	1970mm	1 pcs	2500 ¥

In case of FLT-RL-500/1000 you shall use 5 mounting clip.
In case of FLT-RL-1500/2000 you shall use 10 mounting clip.

Jumper cable FMP-DG



FMP-DG	3000 mm	1 pcs	3500 ¥
--------	---------	-------	--------

Power supply out cable FMP-1



FMP-1	500mm	1 pcs	2500 ¥
-------	-------	-------	--------

Power supply in lead cable FMP-2



FMP-2	500mm	1 pcs	2500 ¥
-------	-------	-------	--------

Power supply unit (OSRAM OT)



OT30/100-200-24-T	30W	1 pcs	Open price
OT60/100-200-24-T	60W	1 pcs	Open price
OT90/100-200-24-T	90W	1 pcs	Open price
OT150/100-200-24-T	150W	1 pcs	Open price

Input AC90~240V, output DC24V.
Comply with CE, UL, PSE standards. IP 66 water proof rating.

DC 24V dimmer FMC-24S/R



FMC-24S/R	1 pcs	34500 ¥
-----------	-------	---------

Available in 3 colors:



DC 24V simple dimmer FSD-24



FSD-24	1 pcs	9900 ¥
--------	-------	--------

Installation / Power supply connection

Mounting rail installation

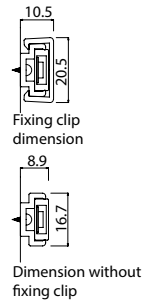
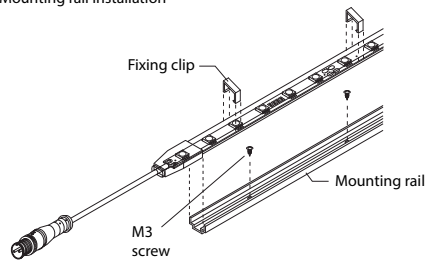

Mounting bracket installation

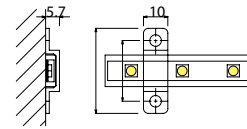
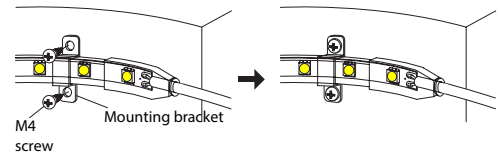

* Please always use washers when fixing the brackets.

Installation / Power supply connection

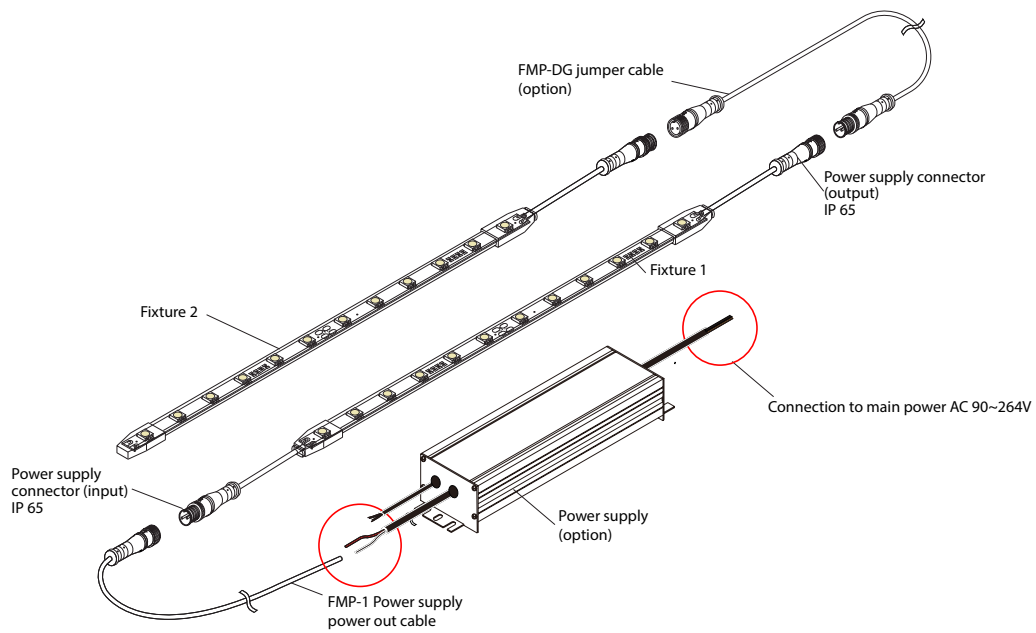

Corporate Profile

Address	11 Tsutsumisoto-cho Kisshoin Minami-ku, 601-8399 Kyoto, JAPAN TEL: 075-314-8760 FAX: 075-314-4167
Establishment	1954/02
Capital	1,0000000 JPY
Founder	CEO Kazuo Kawata
Employees	188 (2022/01)
Main sites	Head Office (Kyoto), Fukuchiyama plant (I and II), Suzhou plant
Representative office	Tokyo, Osaka, Nagoya, Sendai, Fukuoka
Branch	Suzhou, Seoul
Member organization	Japan LED Association (JLEDS) Kyoto Chamber of commerce



Corporate philosophy

At FKK we are constantly thinking about how to contribute to today's environmental challenges via solutions and systems to save energy and create a brighter world. We are continuously looking for innovative and smarter solutions and achieve our goal through customer's satisfaction. We are building harmony between people, foster a supportive and dynamic workplace, and deal sincerely with all tasks and people we encounter. We believe in prospering by bringing prosperity to society as a whole. With every new challenge, we seek to develop unique solutions from a fresh perspective, driving the growth and advancement of our company. We achieve this through strong principles to ensure a permanent and responsible prosperity, considering human, human development and its relation with environment as the center of our business strategy.

Environment

In a world where our natural environment is a bit more threatened every day, FKK have always been committed to nature. Considering the environmental protection as an essential purpose, in compliance with environmental standards (ISO 14001, REACH and RoHS) FKK designs and develops solutions that are more respectful of nature.

Quality

FKK gain the satisfaction and trust of the customer by drawing on unique technology and skills. We take customer's point of view all the time and constantly improving customer satisfaction, responsiveness and the ability to take prompt and effective action. FKK put the quality management system (ISO 9001) to effective use and constantly improve the quality of products and services.

History

- 1954.02: Foundation of Fuji Kogyo Kabushikikaisha in Kyoto, Japan
- 1957.02: Production of spark plug for agricultural machinery
- 1970.02: First production of igniters for oil burner
- 1985.02: The headquarter moved to Kisshoin, Kawata Genjiro becomes president of the group
- 1988.04: New factory built in Fukuchiyama
- 2003.02: Establishment of Shanghai subsidiary
- 2005.05: Obtained ISO 9001 certification
- 2006.02: Award of the best top 300 Japanese SME from the Japanese Ministry of Industry
- 2006.02: Award for the Best 21st century's SME from Kyoto prefecture
- 2007.06: Obtaining the ISO 14001 certification. Fuji Kogyo becomes FKK Corporation, a new headquarters is built
- 2008.01: Establishment of LED production laboratory
- 2008.09: First high luminescence LED production
- 2010.02: New plant in Fukuchiyama
- 2012.11: Establishment of Osaka office
- 2013.01: Fukuchiyama ignition electrode plant is automated
- 2014.01: Establishment of Sendai office
- 2014.06: Establishment of Fukuoka office
- 2014.07: Incorporation of FKK Corporation Suzhou
- 2014.10: FKK high CRI lighting selected for Hokusai manga exhibition in Paris
- 2015.10: Establishment of Nagoya office
- 2017.09: Establishment of LED fixtures assembly plant in Fukuchiyama
- 2018.09: New laser cutting and PCB production equipment incorporated
- 2020.01: New surface mounting line and reflow equipment incorporated

Network

Head office / Sales

11 Tsutsumisoto-cho Kisshoin
Minami-ku, 601-8399 Kyoto, JAPAN

TEL +81(0)7-5314-8760
FAX +81(0)7-5314-4167



Tokyo office

Auspice Uchi Kanda 8F, 1-15-18
Kanda, Chiyoda-ku, 101-0047
Tokyo, JAPAN

TEL +81(0)3-6273-7396
FAX +81(0)3-6273-7397



Osaka office

Kurei Igobashi Building 7F, Edohori
1-17-17 Nishi Ku, 550-0002 Osaka,
JAPAN

TEL +81(0)6-6940-7104
FAX +81(0)6-6940-7106



Sendai office

Kadokawa Building 5F, 2-7-30
Chuo, Aoba-ku, 981-0021 Sendai,
JAPAN

TEL +81(0)2-2796-6527
FAX +81(0)2-2796-6526



Fukuoka office

Shinkansen Building No.2 4F,
Hakata-eki-higashi, Hakata-ku,
812-0013 Fukuoka, JAPAN

TEL +81(0)9-2477-3684
FAX +81(0)9-2477-3685



Nagoya office

RIX 2 Building 5F, Marunouchi
3-17-28, Chuo-ku, Nagoya 460-0002,
JAPAN

TEL +81(0)5-5228-6539
FAX +81(0)5-5228-6569



Fukuchiyama Showacho plant

83 Shōwachō,
620-0052 Fukuchiyama, JAPAN

TEL +81(0)7-7345-8761
FAX +81(0)7-7345-8762



FKK Corporation
www.fkk-corporation.com

